

Mounting Detail
MOUNTS TO STRUCTURE

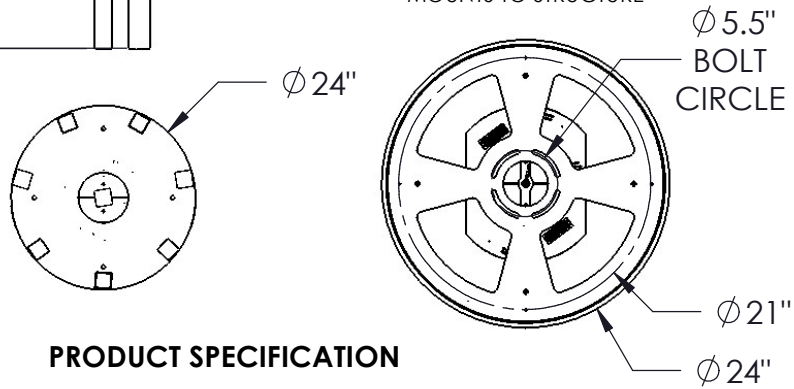

PRODUCT DESCRIPTION

This round multi-pendant chandelier style features our 24", 32" and 40" Axis pendants grouped in a standard configuration beneath a single round canopy. Integrated LED provides beautifully refracted illumination through artisan cast crystal glass, brilliantly crafted from recycled material by Hammerton glass artisans.

PRODUCT SPECIFICATION

Construction: Aluminum Body, Cast Glass, Braided Cord

Finish Options: BS MB FB GB CS GP BB NB

Glass Options: Clear Cast Glass

Suspension Method: Ceiling Mount

Weight (lbs.): 60

UL Rating: Indoor/Dry

Top Diffuser: Closed Metal

Bottom Diffuser: Closed Glass

Light Source: LED

Electrical Qty: 8

Wattage (Watts): 42

Voltage (Volts): 120

Source Lumens: 3362

Dimming: Forward/Reverse Phase to 1%

CCT: Update (2700K or 3000K)

Driver Quantity & Location: 2, in Canopy

CRI: 93+

Power Factor: >0.9

SCAN FOR MORE INFORMATION



GENERAL NOTES:

All dimensions are shown in inches unless otherwise stated.

Visit studio.hammerton.com to read about our Lifetime Limited Warranty.

This product may use mixed materials like steel and aluminum in its construction. Transparent finishes may vary between steel and aluminum.

All Hammerton fixtures are handcrafted by artisans. Subtle imperfections reflect the mark of the artisan and should be expected in any handcrafted product. Dimensions may vary up to 7/8".

© Copyright 2022. All rights in design, detail or invention of this drawing are reserved as the property of Hammerton. Any imitation or adaptation without written consent is strictly prohibited.
Hammerton Inc. 217 Wright Brothers Dr. Salt Lake City, UT 84116 (801)973-8095 | studio.hammerton.com | info@hammerton.com