

Collection: ASTER (NEBULA)

Product #: CHB0062-05

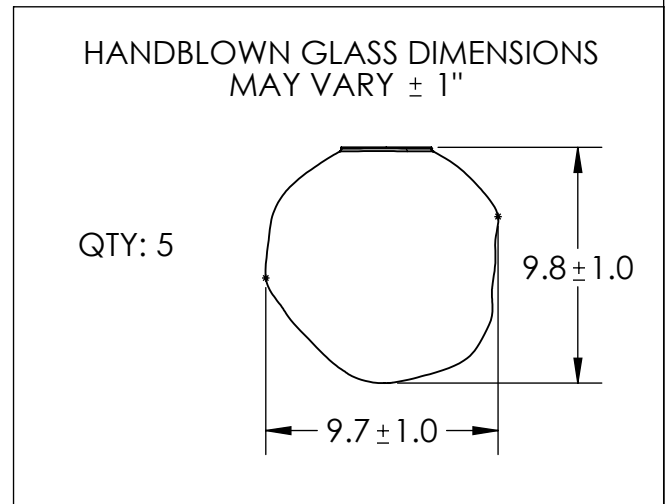
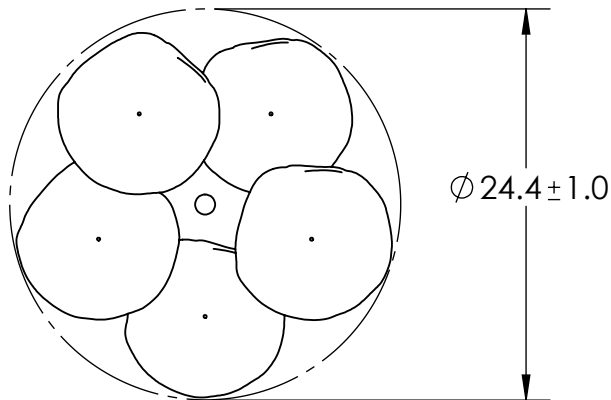
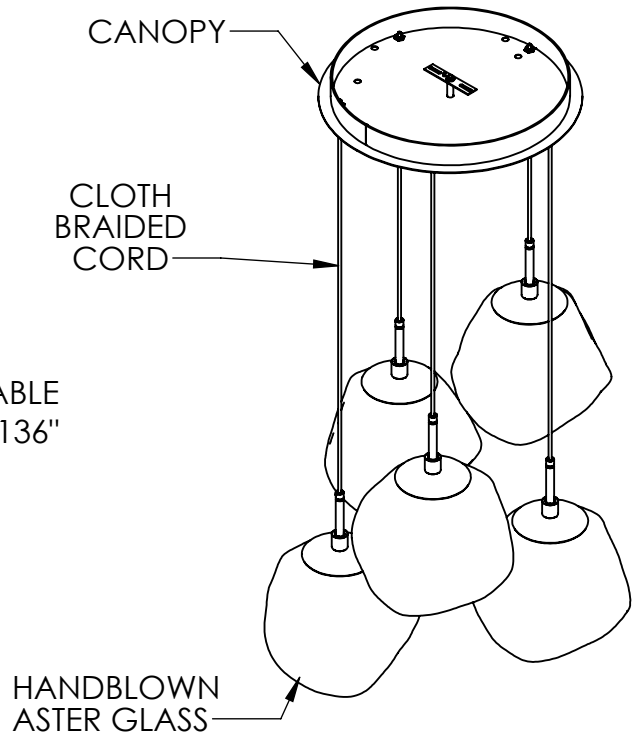
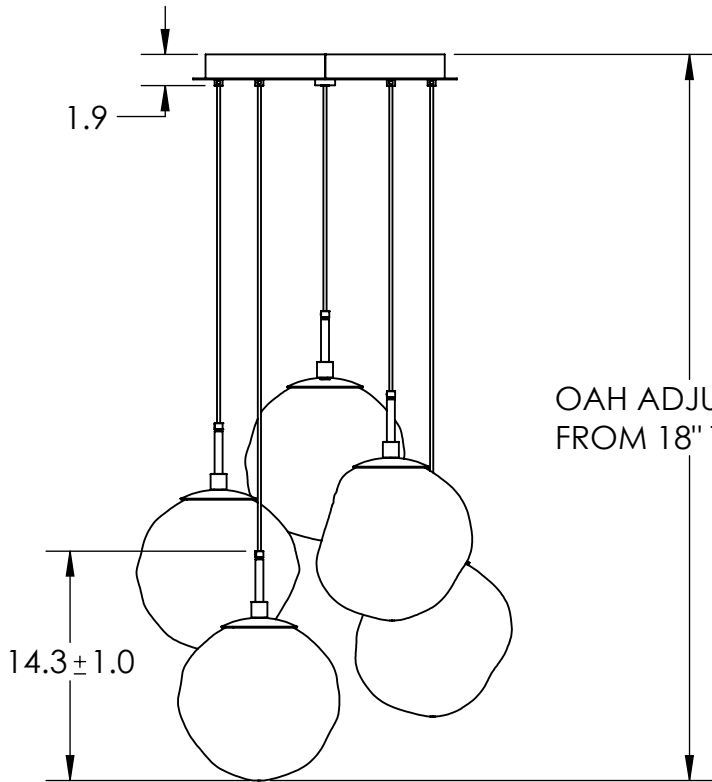

All Dimensions are shown in inches unless otherwise stated. Visit hammertonstudio.com for product options and specifications. *Bulbs Not Included*

1/13/2020 (B)

Mounting Packet: W	Electrical Type: INCANDESCENT
Approximate lbs.: 50	Bulb Qty: 5 Bulb Type: ST19
Finish: SEE WEBSITE FOR OPTIONS	Wattage: 40 Voltage: 120
Top Diffuser: N/A	Socket Type: E26
Bottom Diffuser: CLOSED GLASS	UL Location: DRY

Canopy Mounting Detail

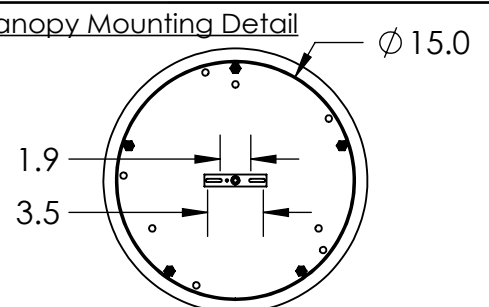

MOUNTS DIRECTLY TO J-BOX

All fixtures created by Hammerton are handcrafted by artisans. Dimensions may vary up to 7/8".

© Copyright 2020. All rights in design, detail or invention of this drawing are reserved as the property of Hammerton. Any imitation or adaptation without written consent is strictly prohibited.

Hammerton Inc. 217 Wright Brothers Dr. Salt Lake City, UT 84116 (801)973-8095