

Collection: GLACIER

Product #: CHB0061-36

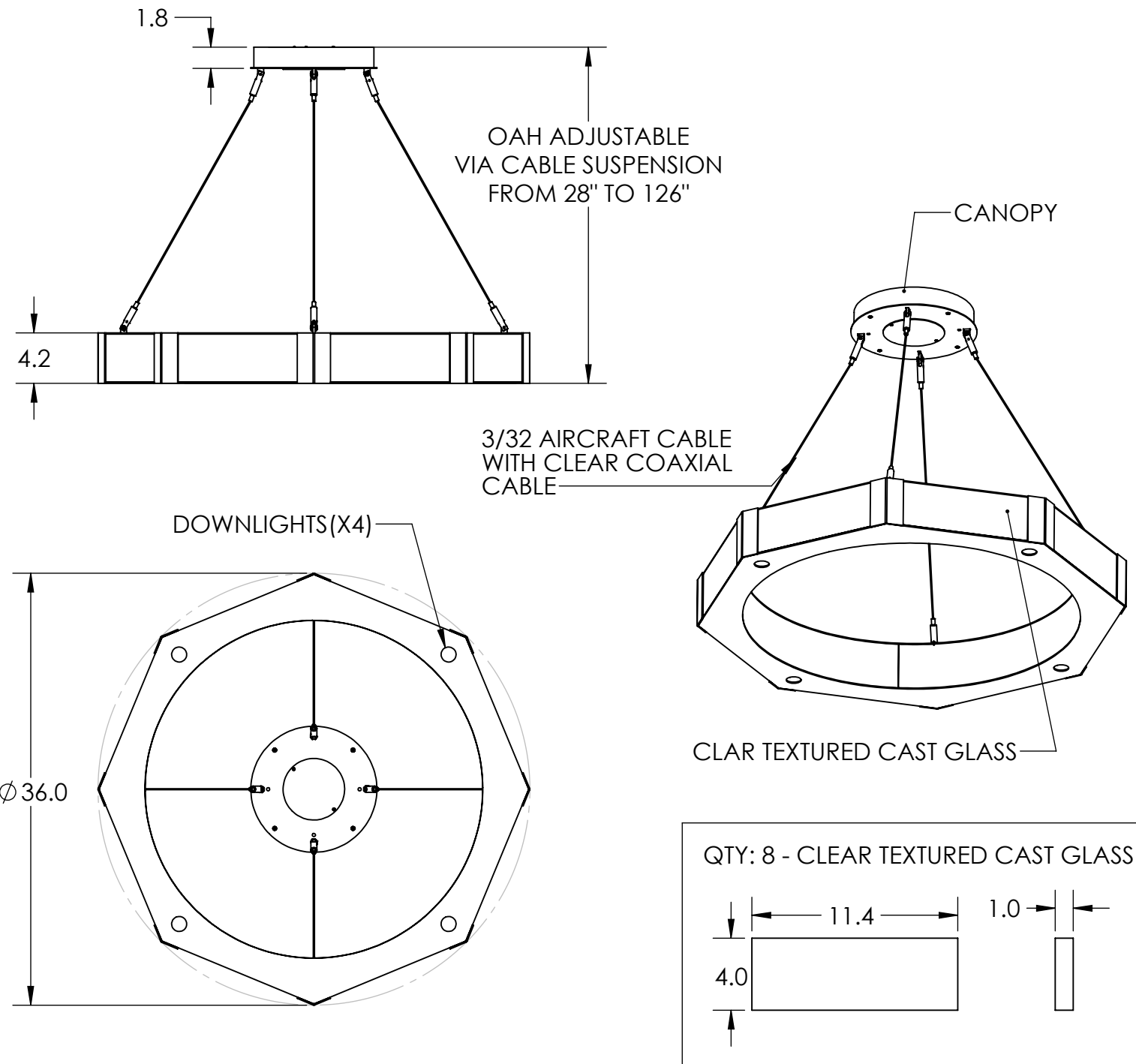

ALL DIMENSIONS ARE IN INCHES UNLESS OTHERWISE STATED
 Visit hammertonstudio.com for product options and specifications.

2/5/2020 ©

Mounting Packet: S	Weight(lbs.): 80	Electrical Type: LED	CCT: 2700 K
UL Location: DRY	Elec. Qty: 20	Wattage: 63	Voltage: 120
Finish: SEE WEB SITE FOR OPTIONS	Source Lumens: Ambient: 2880	Down: 1360	
Top Diffuser: CLOSED METAL	Dimmable: Forward/Reverse Phase To 1%		
Bottom Diffuser: FROSTED ACRYLIC	CRI: 93+	Power Factor: >0.9	

All fixtures created by Hammerton are handcrafted by artisans. Dimensions may vary up to 7/8".

© Copyright 2020. All rights in design, detail or invention of this drawing are reserved as the property of Hammerton. Any imitation or adaptation without written consent is strictly prohibited.

Hammerton Inc. 217 Wright Brothers Dr. Salt Lake City, UT 84116 (801)973-8095

Canopy Mounting Detail

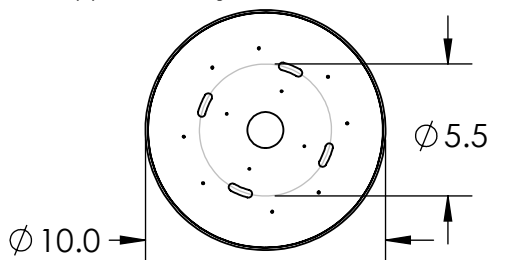

MOUNTS TO BUILDING STRUCTURE